



M10
HEATING IMMERSION CIRCULATOR

Operating manual

! *Before using this instrument, carefully read the operating manual.*

TABLE OF CONTENTS

- INTRODUCTION.....3
 - Intended Use3
 - Appearance and Part Names.....3
 - Indicator and Keypad Description.....4
 - Environmental Conditions4
 - Safety Recommendations.....4
- USING THE M10 Heating Immersion Circulator5
 - Preparation5
 - Powering Instrument ON and OFF5
 - Display in the basic mode6
 - Setting the temperatures7
 - Managing safety systems9
 - Excess temperature protection 10
 - Managing the built-in clock 11
 - Setting the turn on/off timer 12
 - Stopwatch 12
 - Main menu 13
 - Setting the thermal fluid type 14
 - PID controller parameters 15
 - Sensor parameters 17
 - Connecting external sensor 18
 - Temperature correction 19
 - Readiness setting 20
 - Integrated programmer 21
 - Managing refrigerating machine 22
- GENERAL SPECIFICATIONS 23

This manual provides the information needed to operate the M10 heating immersion circulator.

INTRODUCTION

Intended Use

The M10 heating immersion circulator is intended to be used in liquid thermostats with refrigeration machines to control the temperature of specific fluids in a bath tank.

Appearance and Part Names

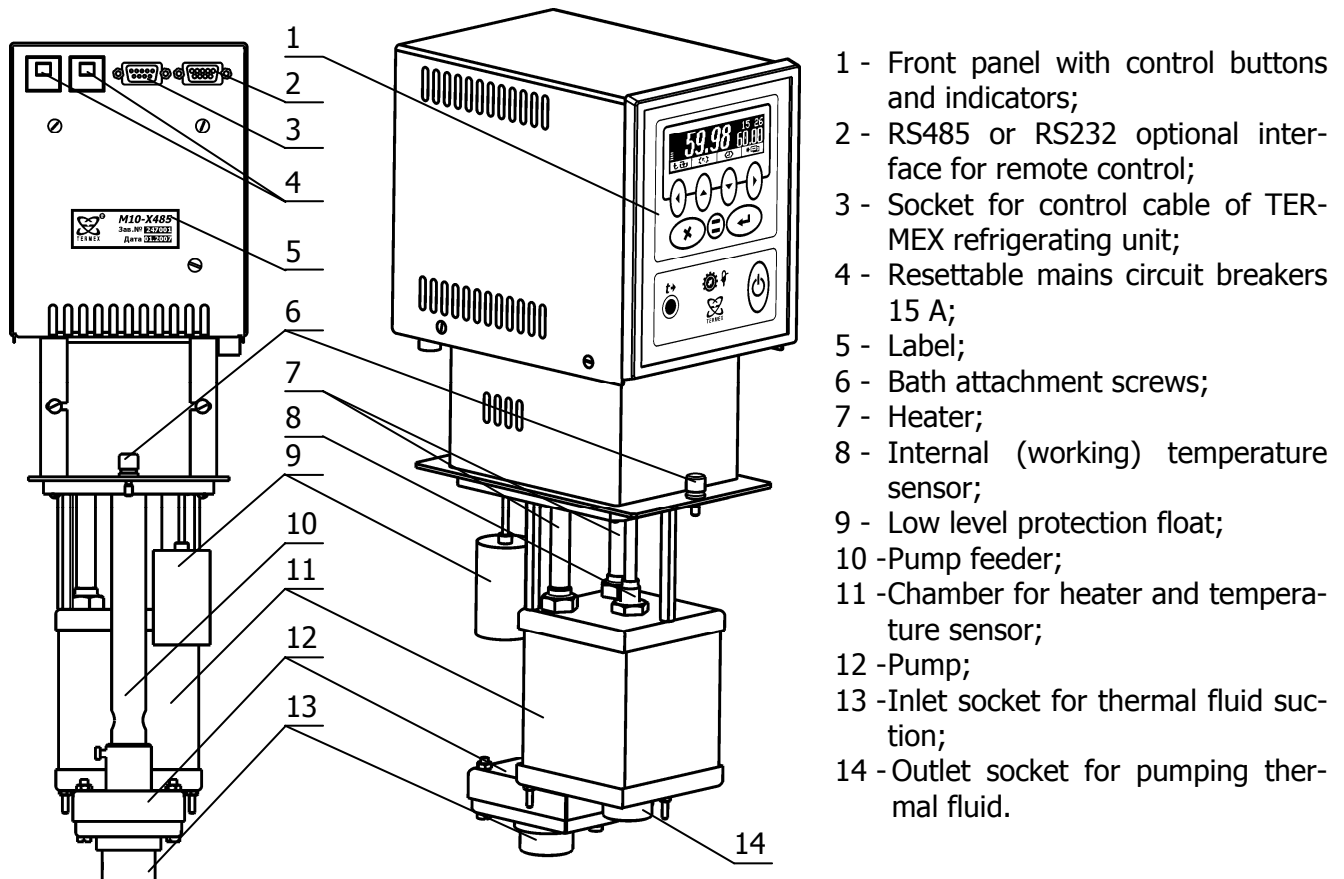

The operating principle of M10 heating immersion circulator is based on supporting a preset constant temperature of flowing thermal fluid, circulated by pump 12 through chamber 11. Thermal fluid is collected with inlet socket 13; and released through outlet socket 14.

The temperature of the thermal fluid in chamber is measured by platinum RTD 8. Microprocessor system compares obtained result to the setpoint, and then calculates a current capacity of the heater 7 so that the thermal fluid temperature would correspond to the given one. The calculation carried out by PID algorithm.

The safety system of the instrument will cut off the power of the pump engine and the heater in case of any malfunctions. In that case circulator produces an audible signal, activates indicator 17 and provides display 15 with the information about malfunction source.

The powering circulator on and off can be mastered by built-in real-time clock. This function is very convenient when circulator is a part of a thermostat.

While operating circulator, display 15 indicates such information as temperature of the thermal fluid, setpoint, current heat capacity, current time and other service information. Setting the operating mode of the instrument is carried out through func buttons on the front panel.

Indicator and Keypad Description

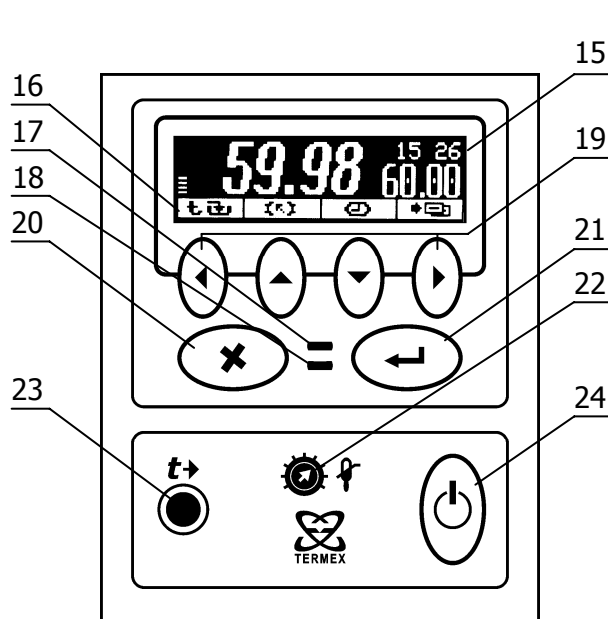

- 15 -LCD display;
- 16 -Icons, that demonstrate the functions of the func buttons 19;
- 17 -Red safety indicator;
- 18 -Green indicator of temperature stabilization;
- 19 -Func buttons, which functions are determined by icons 16. When lack of icons — the buttons are used for moving the cursor or changing parameter values;
- 20 -"Escape" button for cancellation of current action;
- 21 -"Enter" button for confirmation of current action;
- 22 -Adjustable excess temperature protection;
- 23 -Socket for external control sensor;
- 24 -Power button, pressing and holding it for more than 0.5 seconds will turn the power on and off.

Environmental Conditions

Indoor use only.

Ambient temperature: +10...+35 °C.

Air humidity: max. relative humidity 80 % for temperatures up to +31 °C,

Max. mains fluctuation of ± 10 % are permissible.

Safety Recommendations

Avoid strikes to the housing, vibrations, damage to the operating element panel (keypad, display), and contamination.

Do not store the instrument in aggressive atmosphere.

Protect the instrument from contamination.

Make sure that the mains power supply has low impedance to avoid any negative effects on instruments that are being operated on the same mains.

Only qualified personnel are authorized to perform configuration, installation, maintenance and repairs of the circulator.

Routine operation can also be carried out by untrained personnel who should however be instructed by trained personnel.

! *CAUTION: The instrument is not for use in explosive atmosphere.*

USING THE M10 HEATING IMMERSION CIRCULATOR

! **NOTE:** Throughout this manual, keystrokes are represented in **bold type**; references to messages on the display are in "quotes."

Before using M10 heating immersion circulator, carefully read the operating manual.

Preparation

Attach circulator to the bath as described in the thermostat operating manual and secure it with the screws 6.

Connect the instrument to the power supply net.

Powering Instrument ON and OFF

After connecting to the power supply, circulator goes into a sleeping mode. Connecting to the power supply is accompanied by an activation of the display 15 for a short period of time.

While being in sleeping mode, all the functions of circulator, except the clock, are off. The only active button is a power button 24.

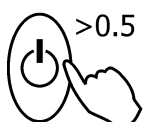
 >0.5 c To turn device on, press and hold power button for more than 0.5 second.

The work of circulator starts with self-test. After the procedure is done, display will indicate the results and carry out the following actions:

Self-test result	Message	Following actions
Instrument functions properly, no errors were found	"Test.....OK"	<ul style="list-style-type: none"> the instrument produces short audible signal turns pump and heater control on and goes over to its basic mode
Primary systems function properly, but errors in subsidiary parts were found	"test...malfunction" e.g.: "test...low battery"	<ul style="list-style-type: none"> the instrument produces prolonged audible signal turns pump and heater control on and goes over to its basic mode
Malfunction in primary or safety systems was found	"Test.....XX"	<ul style="list-style-type: none"> the instrument produces prolonged audible signal the functioning of pump and heater is blocked a message with malfunction info appears on the display

To turn off the circulator, press and hold power button for at least 0.5 second.

Display in the basic mode

Circulator can control temperature of the thermal fluid in two modes:

- setpoint mode;
- profile mode.

Display in the setpoint mode is shown below:

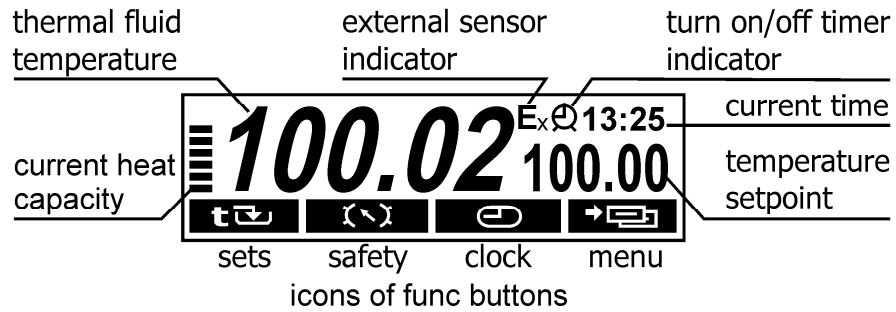

Display in the profile mode is shown below:

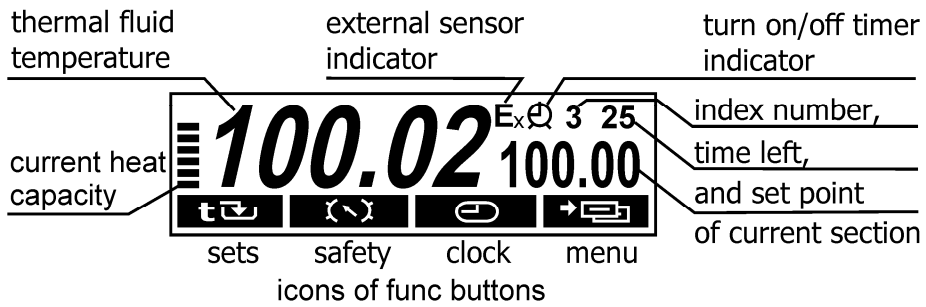



Setting the temperatures

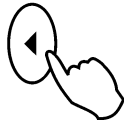

To select the temperature setting mode press (◀) button when appropriate icon is shown on the display.

Memory of the circulator contains values of 3 temperature setpoints and a temperature profile which consists of 10 individual sections defined by duration and target temperature.

A setpoint that controls thermal fluid temperature is called working setpoint. Any out of those 3 setpoints can be selected as a working one. The value of each setpoint is independent from the others.

Operating temperature range depends on the thermostat that is being used along with the circulator (see operating manual for thermostat) and used thermal fluid.

If no buttons are pressed for a long time, the circulator will return to its basic mode.

The procedure of selecting/changing the value of a setpoint is illustrated below:

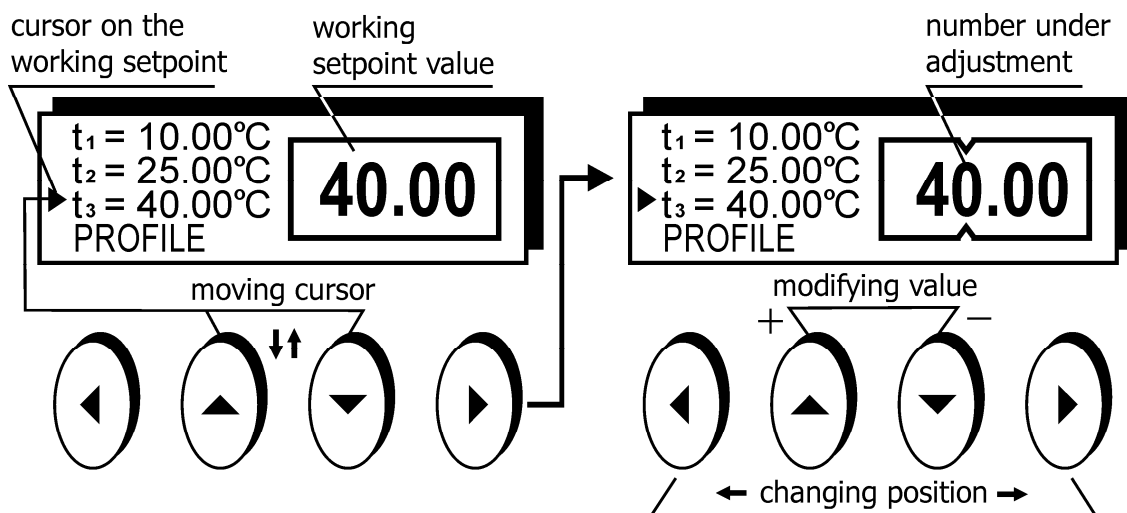

To select a working setpoint use (▲), (▼) buttons to move the cursor. The setpoint value with the cursor will be indicated in the right part of the display. To confirm the selection press (⏩) button, to cancel — press (✕) button.

To change the value of the setpoint press (▶) button. On the box that contains the setpoint value you will see notches that indicate the adjusting position. The selected numeral blinks. Use the increase/decrease (▲), (▼) buttons to change the selected numeral. Press and hold the buttons to make the value increase/ decrease faster. Use (◀), (▶) buttons to move to the next numeral. To accept new value press (⏩) button. To cancel changes press (✕) button.

The example of adjusting setpoint 3 from 40 °C to 150 °C is shown below:

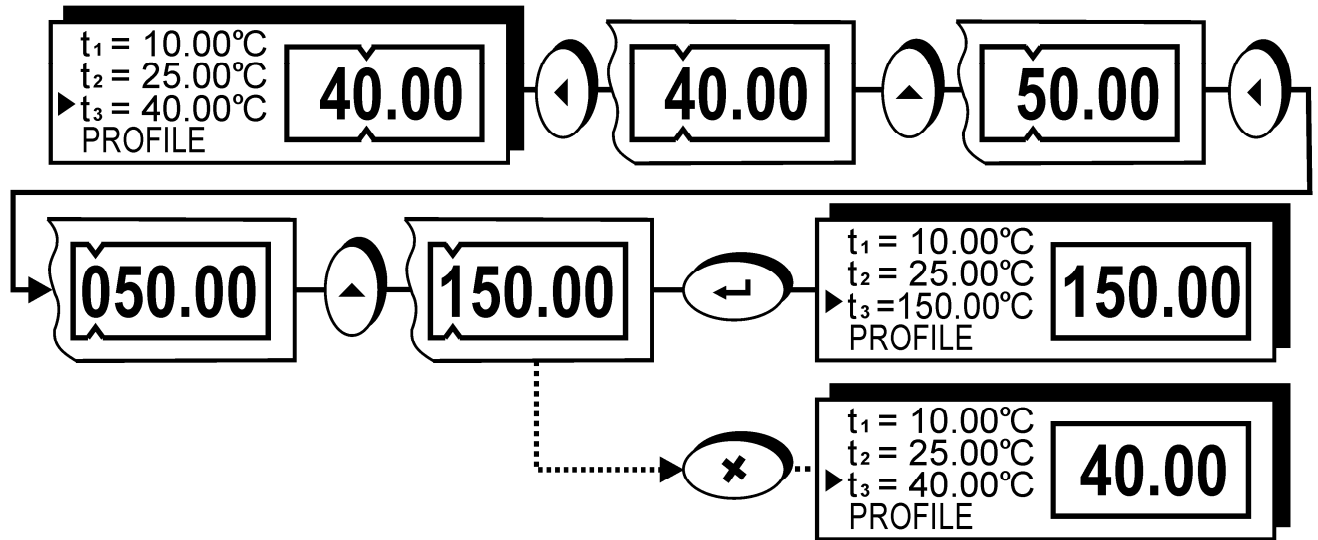



Managing safety systems

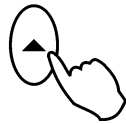

To select the safety systems managing mode press (▲) button when appropriate icon is shown on the display.

Titles and short descriptions of safety systems are provided below:

Title	Description
Fluid	Adjustable excess temperature protection
Level	Low liquid level protection
Pump	Pump engine temperature protection
Heater	Monitoring of the heater state and circuit malfunction protection

If any of the safety systems is triggered, the circulator automatically goes over to the safety systems managing mode.

When a safety system is triggered, the instrument produces an audible signal and illuminates red safety system indicator. A complete shutdown of the heater and circulating pump is affected. Display indicates the current state of the safety system.

Display state while the low level protection is triggered is shown below:

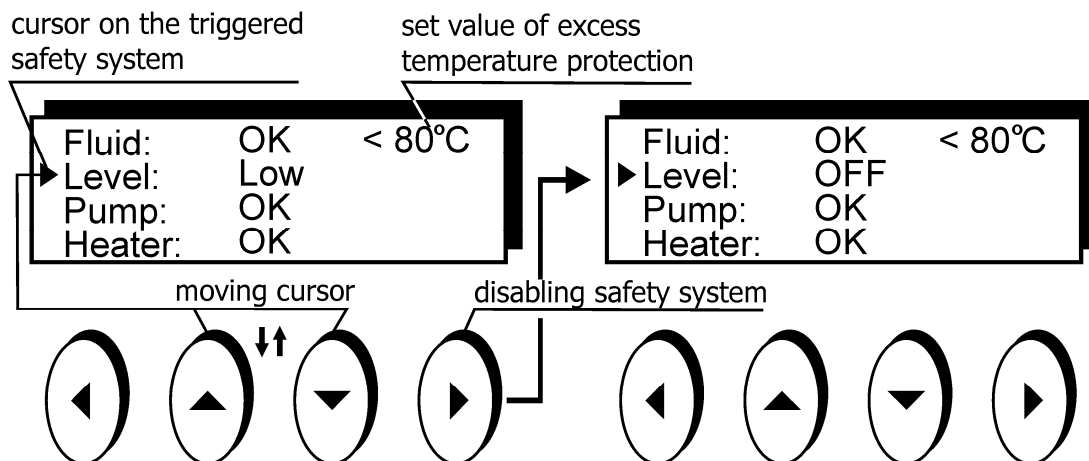

To return to the basic mode:

- eliminate the cause of the safety alarm;
- or
- disable the proper safety system with (►) button.

! *However, operating the instrument with any safety system off is dangerous. So please don't disable safety systems unless the problem is in the safety system itself.*

! *The circulator with any disabled safety system should not be operated without supervision.*

After eliminating the cause of triggering safety system or disabling it with (►) button, red indicator goes out. Return to the basic mode by means of (◀) button.

Excess temperature protection

Set value of excess temperature protection should not exceed the upper working limit of thermal fluid. Definition of the ultimate thermal fluid temperature is illustrated below:

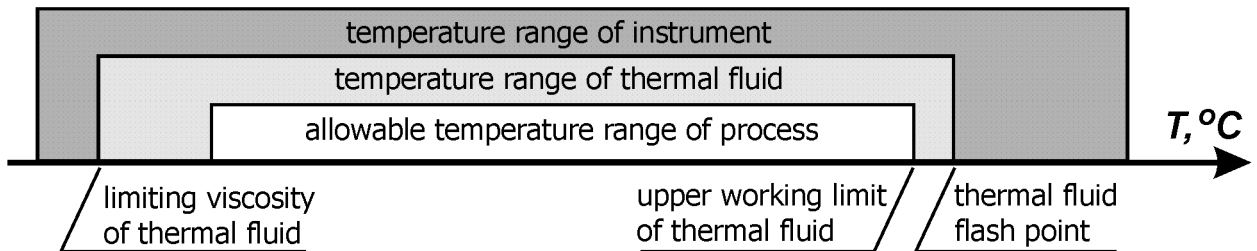

! *The value of excess temperature protection should be set at least 25 °C below the flash point of the thermal fluid.*

! *For the proper functioning of the circulator, the thermal fluid viscosity should be less than 40 mm²/s.*

When selecting the thermal fluid type, excess temperature protection suggests temperature range.

Excess temperature protection is set by rotation of knob 22. Set a new value using a screw-driver.

! *For extra safety of biological sample, for example, set the excess temperature protection as close as possible to the working temperature.*

For precise setting of the excess temperature protection:

- turn temperature protection knob clockwise up to the stop;
- select the desired temperature setpoint;
- as the temperature reaches the setpoint, turn the knob counter-clockwise till it triggers the protection;
- slowly turn the knob clockwise till red indicator goes out;
- press (←) button to set the circulator in the basic mode.

For approximate setting of the excess temperature protection:

- go to safety systems managing mode;
- adjust excess temperature with the knob, checking its value on the display;
- press (←) button to set the circulator in the basic mode.

Excess temperature setting accuracy is 5 °C. Adjusting numerical value is accompanied by distinctive clicks.

To check this safety installation:

- set the working temperature 10 °C above the excess temperature protection;
- watch temperature value on the display;
- when that temperature is accompanied by an audible signal and red indicator illumination, that means that this value triggered the safety system.



Managing the built-in clock

To select the built-in clock managing mode press (▼) button when appropriate icon is shown on the display.

The built-in clock allows the circulator to go over to the basic mode and back to the sleeping mode according to a set timer (turn itself on/off). Furthermore, the circulator has a function of a stopwatch.

Display in the built-in clock managing mode is shown below:

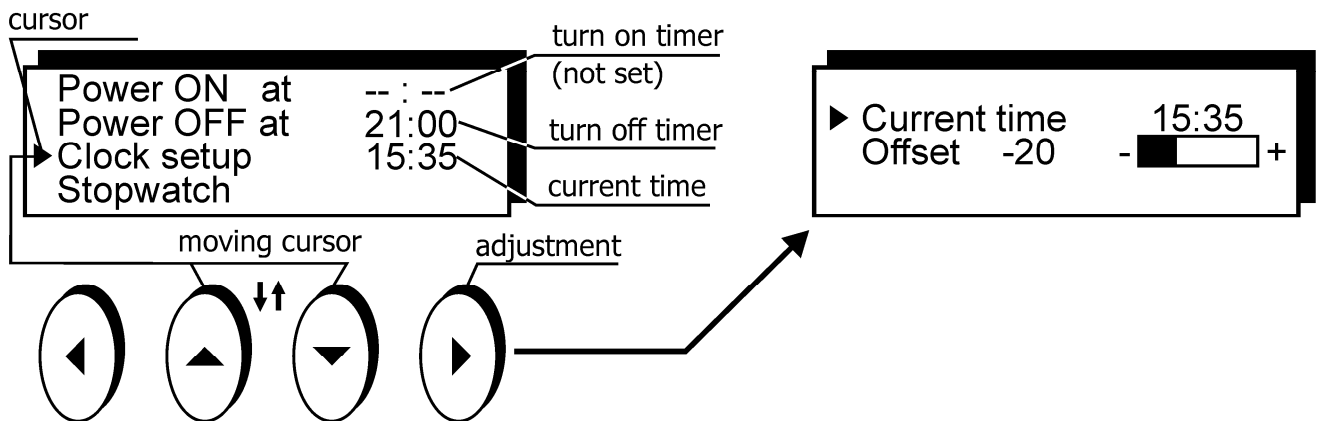

To set the current time:

- with (▲), (▼) buttons put cursor on "Clock setup";
- press (▶) button;
- put cursor on "Current time";
- press (▶) button;
- with (▲), (▼) buttons set the value of the blinking hours "00:00" in the range of 0 to 23, for the fast increasing/ decreasing of the number press the button and hold it;
- with (◀), (▶) buttons go over to the minutes set;
- with (▲), (▼) buttons set the value of the blinking minutes "00:00" in the range of 0 to 59, for the fast increasing/ decreasing of the number press the button and hold it;
- to accept the value of the current time press (↵) button;
- press (↵) button to return to the clock managing mode.

To correct the clock speed:

- with (▲), (▼) buttons put cursor on "Clock setup";
- press (▶) button;
- put cursor on "Offset";
- press (▶) button;
- with (◀), (▶) buttons correct the clock speed: when it is late, use the (▶) button, towards the positive value. To speed the clock up use the (◀) button, towards the negative value;
- to return to built-in clock managing mode press (↵) button.

To return to the basic mode, press (↵) or (✕) button. If no buttons are pressed for a long time, the circulator goes over to its basic mode autonomously.

Setting the turn on/off timer

To set the turn on/off timer:

- enter the built-in clock managing mode with (▼) func button "clock";
- with (▲), (▼) buttons put cursor on desired time (turning on or off);
- to enter the value press (▶) button;
- with (▲), (▼) buttons set the value of the blinking hours "00:00" in the range of 0 to 23, for the fast increasing/ decreasing of the number press the button and hold it;
- with (◀), (▶) buttons go over to the minutes set;
- with (▲), (▼) buttons set the value of the blinking minutes "00:00" in the range of 0 to 59, for the fast increasing/ decreasing of the number press the button and hold it;
- to accept the timer value press (↔) button.

To reset the timer set value press (✕) button. The timer value will look like: "--:--".

After the instrument is turned on or off at a preset time, the timer resets. And the timer will not go on or off on the next day.

The latest timer sets remain in the instrument memory. You can easily go through them by pressing (▶) button. So that you don't have to set the timer for the same time ever again.

Stopwatch

To measure time intervals, the circulator conveniently has a function of stopwatch.

Display in the stopwatch mode is shown below:

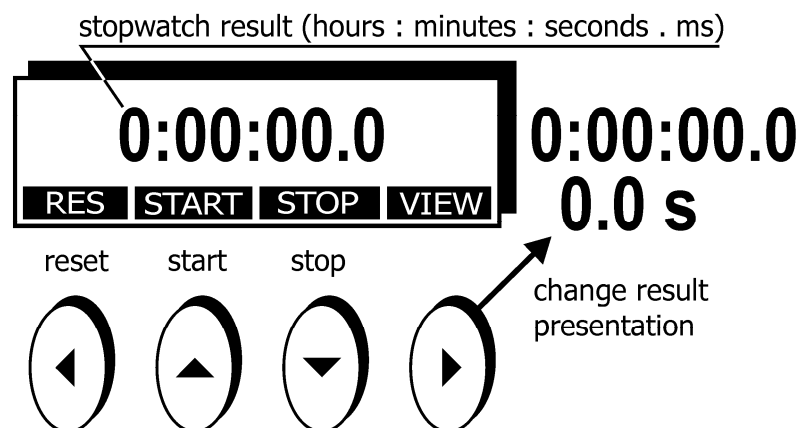

To select the stopwatch mode from built-in clock managing mode:

- with (▲), (▼) buttons put cursor on "Stopwatch";
- press (▶) button.

Description of func buttons in this mode:

- RES (◀) button — resets result to zero;
- START (▲) button — starts count of time from the current result;
- STOP (▼) button — stops the count of time;
- VIEW (▶) button — changes the look of the result.

To exit the stopwatch mode press (↔) button.

! *Exiting the stopwatch mode does not stop or lose current count.*



Main menu

To select main menu press (▶) button when appropriate icon is shown on the display.

The main menu of the circulator consists of the set of items. Each item can be of the following type:

- submenu, which can be in turn:
- selector, meaning that it takes on a fixed value. E.g., "on" or "off";
- number, meaning that it can take on a numerical value;
- set of parameters.

A fragment of main menu of the circulator is shown below:

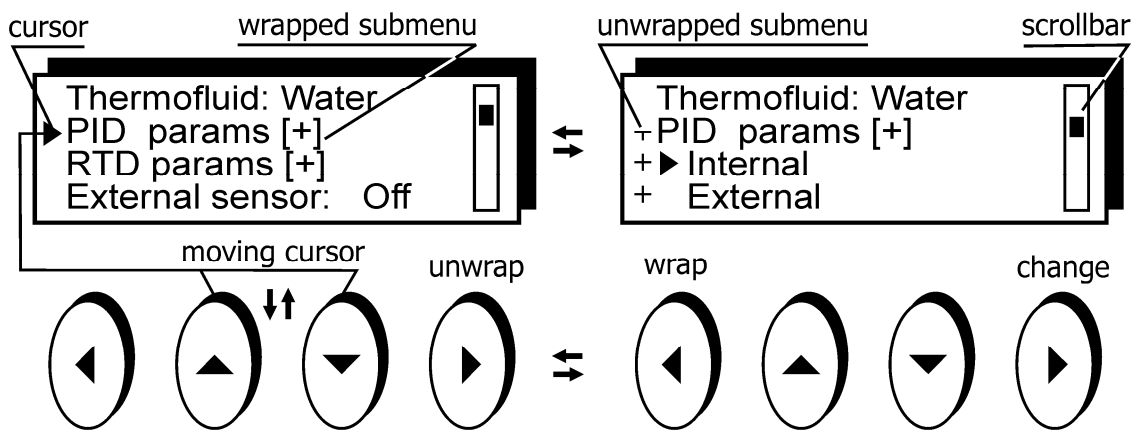

To move cursor across the menu use (▲), (▼) buttons.

Items with the symbol [+] are submenus and can be unwrapped with (▶) button. When a submenu is unwrapped, cursor can be moved between the submenu items only.

To wrap the submenu and return to the upper level, press (◀) button.

For those non-submenu items pressing (▶) button will result in:

- for a selector — going over to the next value. E.g., from "on" to "off". The value of the selector changes in a circle — after the last value it goes back to the first one;
- for a number — beginning of entering a new value;
- for a set of parameters — procedure of editing the parameters.

Setting the thermal fluid type

For proper functioning of the circulator set the type of the thermal fluid in the main menu. By doing so, the following will be set:

- range of working temperature (setpoints range);
- range of excess temperature protection;
- optimum parameters for temperature control in automatic mode.

The recommended thermal fluids and their working temperature and excess temperature protection ranges are provided in the table below. Temperature values stated below can be limited by the temperature range of the thermostat, which is used along with the circulator.

Thermal fluid	Range of working temperature	Range of excess temperature protection
Distilled water	+5...+90 °C	+15...+100 °C
PMS-5	-50...+100 °C	-40...+110 °C
PMS-10	-30...+130 °C	-20...+140 °C
PMS-20	0...+150 °C	+10...+160 °C
PMS-50	+50...+180 °C	+60...+190 °C
PMS-100	+100...+300 °C	+110...+310 °C
Ethanol	-80...-10 °C	-70...0 °C
Coolant	-30...+95 °C	-20...+105 °C

! While heating polymethylsiloxane thermal fluids (PMS) with the viscosity at temperature of more than 40 mm²/s, the circulator uses soft regime with limited capacity. This reduces the thermal degradation of fluid and increases the duration of its use.

The procedure of selecting the thermal fluid type is illustrated below:

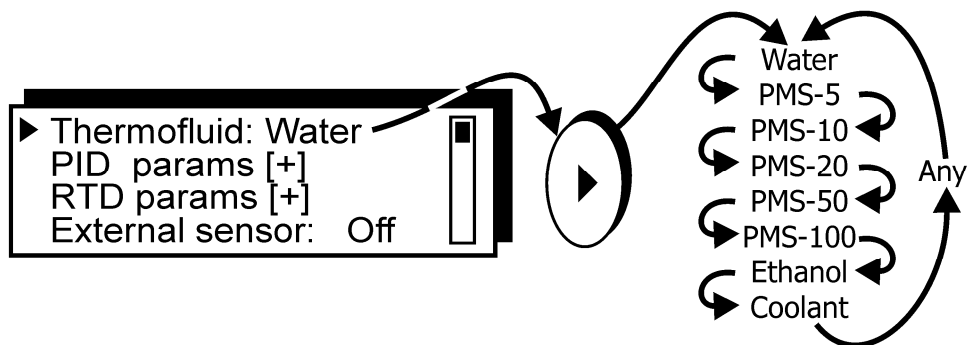

To select the thermal fluid type:

- with (▲), (▼) buttons put cursor on "Thermofluid";
- using (▶) button, select the proper thermal fluid from the list above.

If the fluid you use is not on the list, select "Thermofluid: Any". In that case the range of working temperature and excess temperature protection will be determined by the thermostat that is used along with the circulator.

PID controller parameters

The purpose of PID temperature control is to correct the error between a measured temperature and a desired setpoint by calculating heat capacity that can adjust the thermal fluid temperature accordingly and rapidly, to keep the error minimal.

Calculated heat capacity depends on:

- the current error — proportional term;
- the sum of recent errors — integral term;
- the rate at which the error has been changing — derivative term.

The circulator has two PID controllers:

- internal — assumes the internal sensor data as input variable;
- external — assumes the external sensor data as input variable;

To select the PID controller parameters editing mode:

- with (▲), (▼) buttons put cursor on "PID params";
- press (▶) button to unwrap submenu;
- with (▲), (▼) buttons select needed PID controller: "Internal" or "External";
- press (▶) button to enter the PID controller parameters editing mode.

Display in the mode of editing the parameters of internal PID controller is shown below:

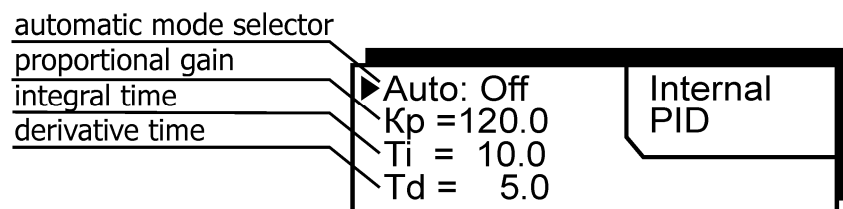

Automatic (self-adjustable) mode of PID controller allows obtaining a satisfactory quality of controlling in wide temperature range for different types of thermal fluids. Though sometimes, for example, when operating an external control sensor, utilizing PID controller with unchangeable parameters is more preferable, because the result is more predictable. That is why the option of disabling automatic mode is available.

To turn automatic mode of PID controller on/off:

- with (▲), (▼) buttons put cursor on "Auto";
- press (▶) button to select the mode.

To adjust numerical value of PID controller parameter:

- put cursor on the value with (▲), (▼) buttons;
- press (▶) button;
- with (▲), (▼) buttons set the desired value, moving the blinking cursor with (◀), (▶) buttons;
- to accept a new value press (↵) button. To cancel changes press (✕) button.

To return to the main menu press (↵) or (✕) button.

While using PID controllers with unchangeable parameters, factory setting values give satisfactory results. If the parameters of PID controllers need some correction, their values should be defined by experiment.

First of all, proportional gain K_p should be determined. In order to do that, set the integral and derivative time to be zero: $T_i = 0.0$ и $T_d = 0.0$. Then plot a temperature versus time chart for thermal fluid step response. The setpoint should be higher than initial temperature of the thermal fluid. Possible types of step response are shown below:

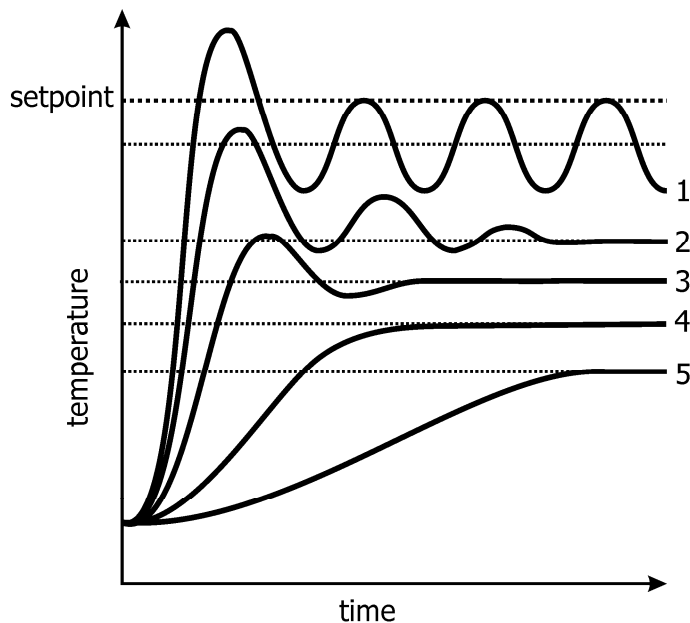

- 1 - The value of K_p is too high, it should be significantly reduced.
- 2 - Damped oscillations are observed. If derivative term going to be used, K_p has optimal value. If derivative term is not intended to be used, K_p should be reduced in order to obtain step response of type 3 or 4.
- 3 - A small overheat and rapidly damped oscillations are observed. If overheating is allowed, K_p has optimal value.
- 4 - Temperature smoothly reaches a steady value without overheating or oscillations.
- 5 - Reaching a setpoint takes a long time, K_p value should be increased.

Note: in the cases above the steady temperature of thermal fluid does not correspond to the setpoint value. This static error can be eliminated by adding an integral term.

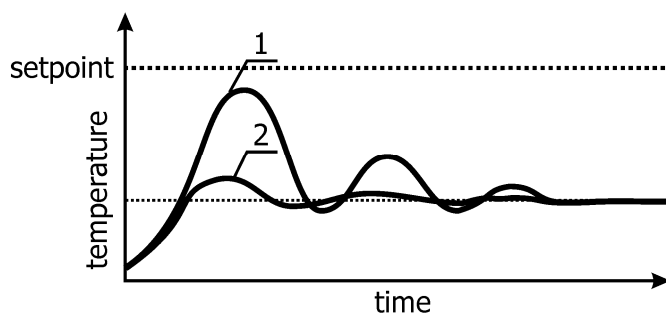

To define the derivative time T_d , proportional gain K_p should be set in the way that step response is compliant with curve 1. The derivative time T_d should be selected so, that step response becomes curve 2.

After defining proportional gain and, if needed, derivative time, an integral time should be defined. Integral term is intended for eliminating residual error between a steady temperature value and a setpoint.

Types of step response for various integral times are shown below:

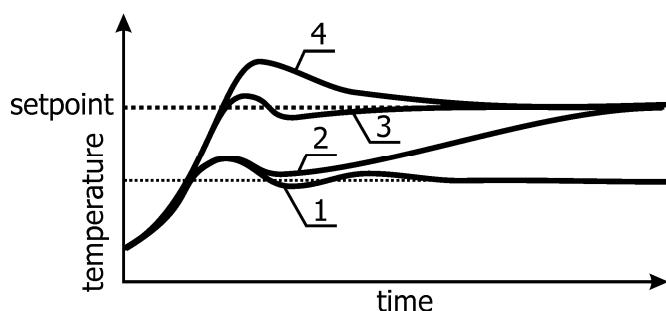

- 1 - Integral term is missing ($T_i = 0.0$).
- 2 - Reaching a setpoint takes a long time, T_i value should be reduced.
- 3 - Integral time T_i has optimal value.
- 4 - Overheat is too significant, T_i should be increased.

Sensor parameters

The circulator contains an internal (working) temperature sensor, but an external sensor may be attached to connector 23, as well.

Every sensor is a Platinum Resistance Temperature Device (Pt1000 RTD), which has its own independent set of parameters:

▶ R = 1000.0 A = 3.9083E-3 B = -5.7750E-7 C = -4.1830E-12	Int. sensor
--	----------------

Every sensor has 1000 Ohm resistance at 0 °C and a custom coefficients for Pt RTD with $W_{100} = 1.385$:

- $A = 3.9083 \times 10^{-3} \text{ } ^\circ\text{C}^{-1}$
- $B = -5.7750 \times 10^{-7} \text{ } ^\circ\text{C}^{-2}$
- $C = -4.1830 \times 10^{-12} \text{ } ^\circ\text{C}^{-4}$

If necessary, an individual calibration of any sensor according to standard thermometer can be realized; and its parameters can be adjusted.

To select the parameter editing mode:

- with (▲), (▼) buttons put cursor on "RTD params";
- press (▶) button to unwrap submenu;
- with (▲), (▼) buttons select needed sensor: "Internal" or "External";
- press (▶) button to enter the parameter editing mode.

To adjust numerical value of sensor parameter:

- with (▲), (▼) buttons put cursor on the parameter;
- press (▶) button;
- with (▲), (▼) buttons set the desired value, moving the blinking cursor with (◀), (▶) buttons;
- to accept a new value press (↵) button. To cancel changes press (✕) button.

To return to the main menu press (↵) or (✕) button.

Connecting external sensor

To accurately maintain the thermal fluid temperature in external systems, circulator provides an external sensor connection.

For external control and temperature measurement an external Pt1000 sensor must be connected to the socket 23 on the front panel of the circulator.

Switching to external control mode in main menu:

- with (▲), (▼) buttons put cursor on "External sensor";
- by pressing (▶) button, set "External sensor: On".

In the basic mode display will indicate the value of thermal fluid temperature measured by external sensor. Furthermore, "indicator of external sensor control" will be activated.

When the circulator functions along with external sensor, PID controllers perform cascade control (as shown in the figure below):

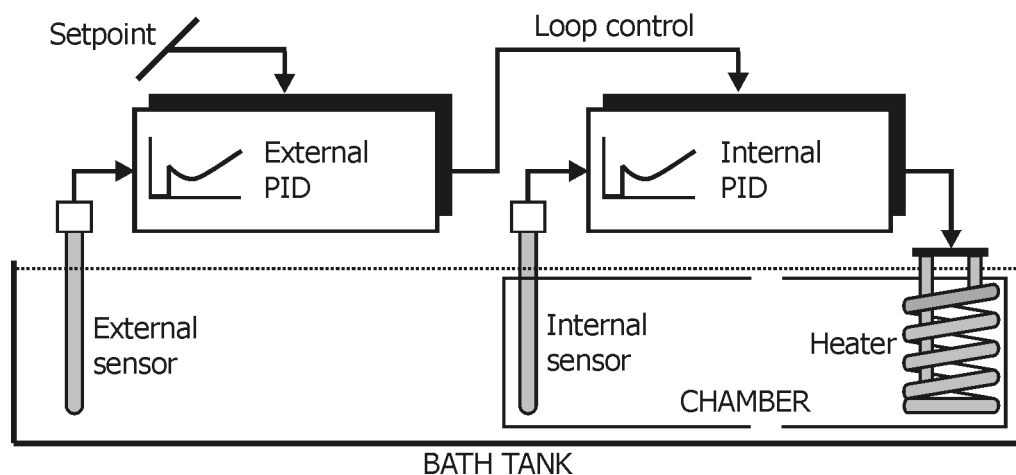

Cascade control uses the output of the primary (external) PID controller to manipulate the setpoint of the secondary PID controller as if it were the final control element.

! *When using PID controllers in non-automatic mode, integral time of external controller should be much more than integral time of internal one: $T_{i_{ext}} > 10 \times T_{i_{int}}$*

Temperature correction

Display indicates thermal fluid temperature, measured by control sensor. This temperature usually does not correspond to the actual temperature in the bath tank or thermal fluid temperature in the external system.

The difference between those temperatures is determined by measuring actual temperature by means of test thermometer; and is entered in the circulator as a correction factor, which is saved in the instrument memory and added to measured temperature of the thermal fluid.

To adjust correction value:

- with (▲), (▼) buttons put cursor on "Correction, °C";
- press (▶) button;
- with (▲), (▼) buttons set the desired value, moving the blinking cursor with (◀), (▶) buttons;
- to accept a new value press (↵) button. To cancel changes press (✕) button.

Example of determining correction value is shown below:

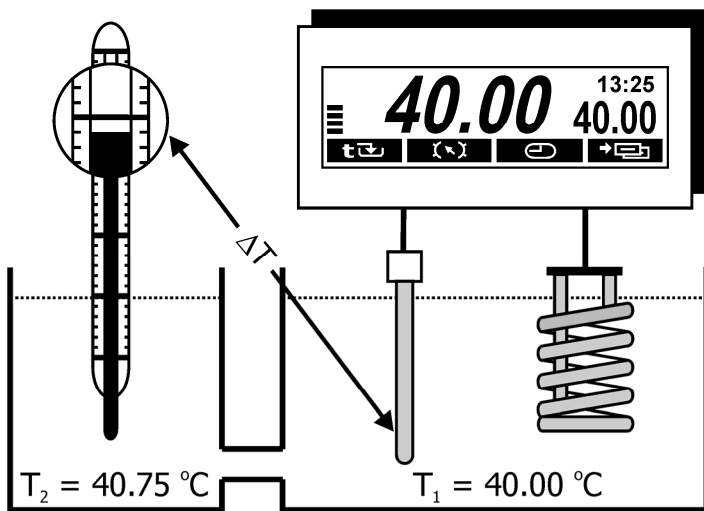

- Wait until the temperature of thermal fluid is steady on the display.
- Place standard thermometer in the thermal fluid.
- Determine correction value as difference between the temperature, measured by standard thermometer and temperature on the display:

$$\Delta T = T_2 - T_1$$

$$\Delta T = 40.75 \text{ °C} - 40.00 \text{ °C} = 0.75 \text{ °C}$$

- Enter correction value in the instrument memory as described above.

Readiness setting

Green indicator of temperature stabilization 18 lights up in case of the difference between set-point and current temperature of thermal fluid does not exceed the value, set in menu item "Readiness", at least for one minute.

When the green indicator lights up, PID parameters adjusting procedure ends, if PID controller is in automatic mode.

To set the value of the readiness:

- with (▲), (▼) buttons put cursor on "Readiness, °C";
- press (▶) button;
- with (▲), (▼) buttons set the desired value, moving the blinking cursor with (◀), (▶) buttons;
- to accept a new value press (↵) button. To cancel changes press (✕) button.

! *Minimum value of readiness is 0.02 °C.*

! *Do not set a low value of readiness if not necessary. Unjustified decreasing of readiness value makes the process of automatic setting of PID controller longer.*

Integrated programmer

The integrated programmer allows any desired temperature program sequences to be realized. Such a temperature sequence is called profile. A profile consists of individual sections defined by duration and target temperature. Target temperature is the setpoint that is achieved at the end of a section. The programmer uses time and temperature difference values within a section to calculate a temperature ramp.

Entry to the procedure of editing the profile from temperature setting mode is shown below:

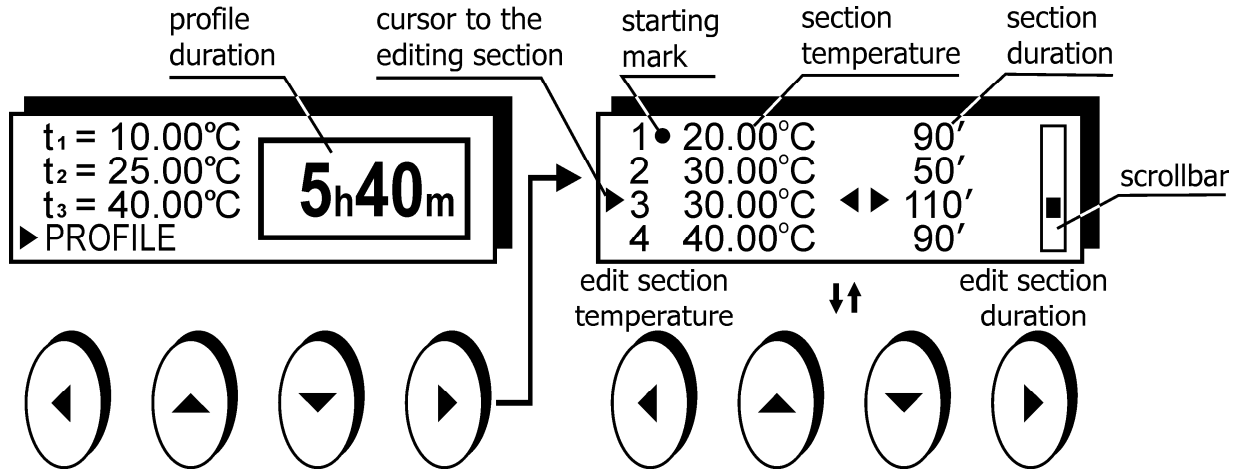

Executing a profile that consists of 4 sections is shown below:

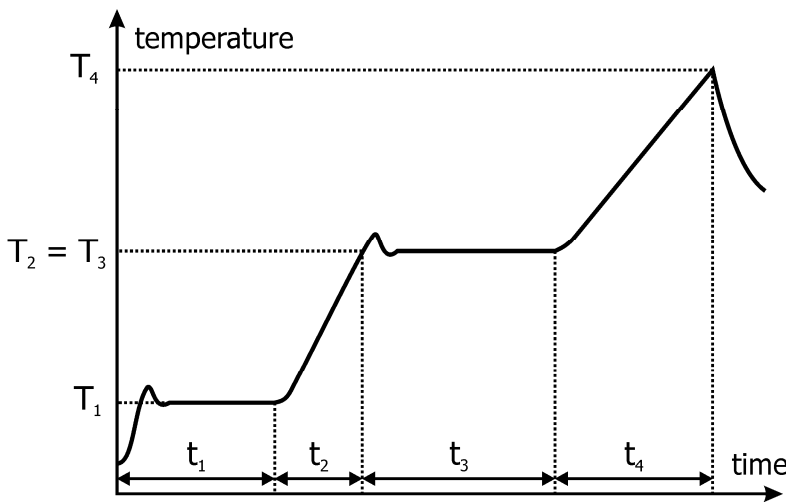

- When the profile is started, thermal fluid temperature is controlled to $T_1 = 20.00\text{ °C}$ and keeps steady for $t_1 = 90\text{ min}$.
- Thermal fluid temperature is controlled to $T_2 = 30.00\text{ °C}$ with the ramp of $(T_2 - T_1)/t_2 = 0.2\text{ °C/min}$. When temperature reaches T_2 , the profile proceeds to the next section.
- Thermal fluid temperature keeps steady at $T_2 = 30.00\text{ °C}$ for $t_3 = 110\text{ min}$.
- Thermal fluid temperature is controlled to $T_4 = 40.00\text{ °C}$ with the ramp of $(T_4 - T_3)/t_4 = 0.11\text{ °C/min}$.

All sections with nonzero duration are carried out one by one. The sections with zero duration are skipped while running the profile.

If the temperature of some section is equal to the temperature of the previous section, that section is static. The purpose of such section is to keep thermal fluid temperature steady for a certain time.

If the temperature of some section is different from the temperature of the previous section, that section is dynamic. The purpose of such section is to keep constant temperature ramp of thermal fluid. The ramp is determined by the difference of temperatures between a current and a previous section, divided by duration of the current section: $V = (T_{\text{current}} - T_{\text{prev}}) / t_{\text{current}}$. Executing dynamic section will end when target temperature is reached even if it takes more or less time than it was set in section duration.

The first section is always static. The difference of the first static section from other static ones is that temperature control starts with the current temperature of the thermal fluid.

When the last nonzero section is executed, the circulator goes over to a sleeping mode.

! *Make sure that the sections are executable, because maximum temperature ramp is limited by thermal fluid amount, its heat capacity, heat exchange with environment and other parameters.*

To edit the temperature profile:

- by pressing func button "sets" select the temperature setting mode;
- with (▲), (▼) buttons put cursor on "PROFILE";
- press (▶) button;
- with (▲), (▼) buttons put cursor on section that is being edited;
- press (◀) button to edit section temperature;
- with (▲), (▼) buttons set the desired value, moving the blinking cursor with (◀), (▶) buttons;
- to accept a new value press (↵) button. To cancel changes press (✕) button.
- press (▶) button to edit section duration;
- with (▲), (▼) buttons set the desired value, moving the blinking cursor with (◀), (▶) buttons;
- to accept a new value press (↵) button. To cancel changes press (✕) button.
- edit parameter values for every section the same way;
- press (↵) button to finish editing the profile.

Running a profile is shown below:

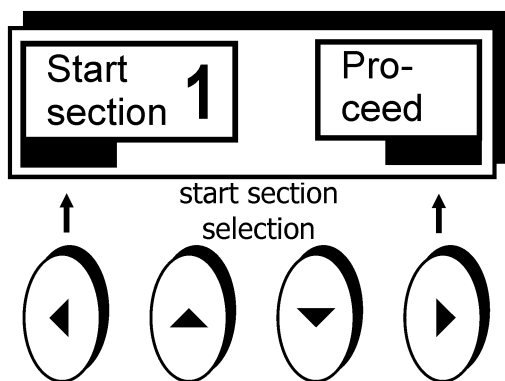

To run a profile:

- by pressing func button "sets", select the temperature setting mode;
- with (▲), (▼) buttons put cursor on "PROFILE";
- press (↵) button;
- with (▲), (▼) buttons select the number of starting section, it will be indicated with mark "●" in the profile editing mode;
- run the profile by pressing (◀) button.

If the profile has already been in progress when selecting the temperature setting mode, you can continue executing it by pressing (▶) button.

Managing refrigerating machine

To enter refrigerating machine managing mode:

- with (▲), (▼) buttons put cursor on "Fridge control";
- by pressing (▶) button set "Fridge control: On".

In this mode the circulator forms commands for control of refrigerating machine capacity, which are delivered to the recipient by means of interface 3.

GENERAL SPECIFICATIONS

Working temperature range	-100...+150 °C
Set-point resolution	0.01 °C
Display resolution	0.01 °C
Heating capacity	2000 W
Pump capacity:	
• pressure	0.27 bar
• flow rate	15 l/min
Working sensor	Pt1000
Temperature control	Improved PID
Absolute temperature calibration	±0.5 °C
Display	Graphic LCD 128×32
Protection class	IP21
Power supply	230 V, 50/60 Hz
Dimensions, WxDxH	180×125×500 mm
Weight	8 kg
Warranty	2 years
Excess temperature protection	Adjustable -90...+160 °C
Low liquid level protection	Float switch
Heater failure protection	
Integrated programmer for temperature profile consists of 10 sections	
Build-in real time clock and stopwatch	